





Silo 10



The Silo collection inhabits many worlds at once, creating a striking metaphor for duality. Mysterious yet inviting, the true magic lies in how its rhythmic curves shape light and space around it. Made using custom aluminium extrusions, the modular uplight-downlight creates a theatrical yet sleek composition

TYPE	Suspension
CONSTRUCTION	Powder coated, mirror polished or tumbled aluminum body Powder coated canopy Polycarbonate lens Polyurethane cord
SPECIFICATIONS	Power consumption: 29.6W Colour temperature: 3000K 2700K dim to warm 3000K to 2200K dim to warm 2700K to 2200K
CONTROL	120/277V on/off, 0-10V, or phase dimming (120V only) 220-240V: On/Off, Phase Dimming, DALI
CORD LENGTH	120" / 304 cm
STAINLESS STEEL CABLE	96" / 244 cm
WEIGHT	2SB - 3.71lb / 1.4KG 4SA- 5.49lb / 2.5KG
CERTIFICATIONS	    IP20
WARRANTY	2 years

Spec Drawings

Suggested installation

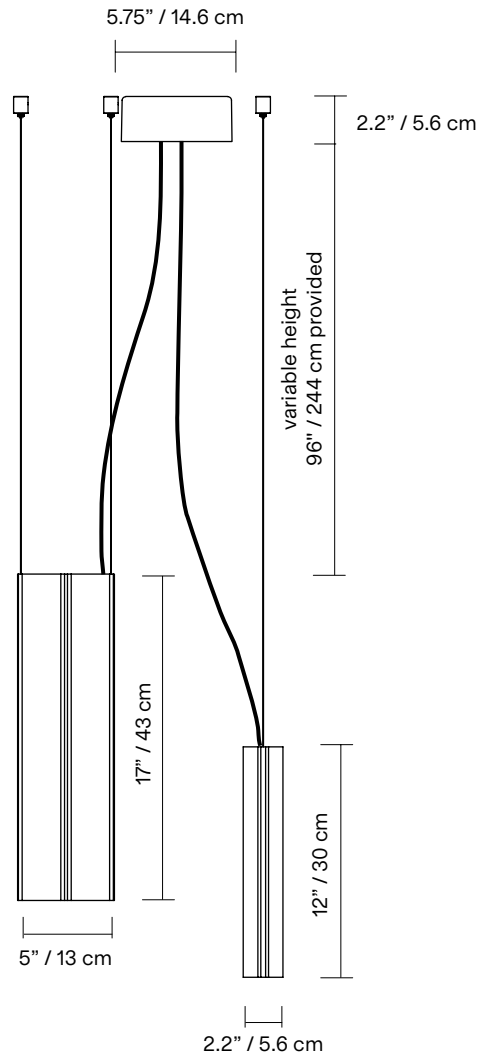
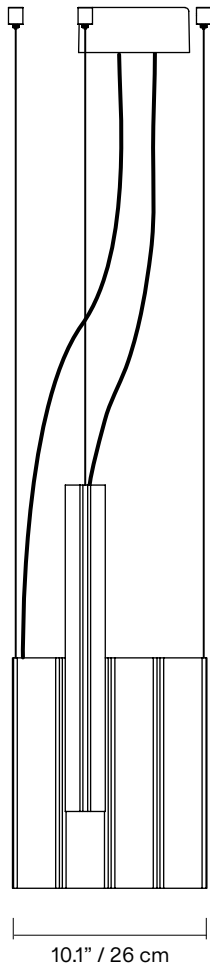
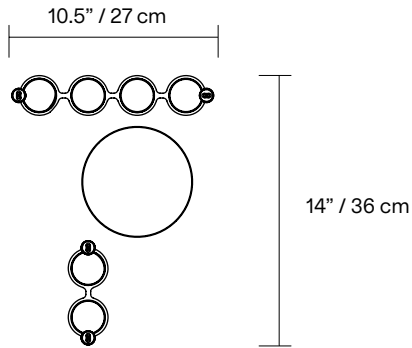

*dimensions are approximate and may vary slightly

FINISH

PALETTE 1



CORD

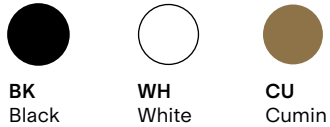

MOUNTING

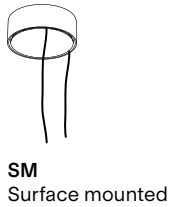

CONFIGURATION

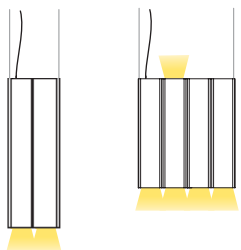

NOTES

- Must be installed by an electrician
- Ceiling anchors not meant for slanted ceilings (available upon request)
- LED may only be changed by Lambert & Fils or other authorized personnel
- Not protected against liquids (refer to IP20)
- Additional charges for modifications or for special orders
- Please refer to maintenance sheet on our website for cleaning instructions

LAMP ANATOMY

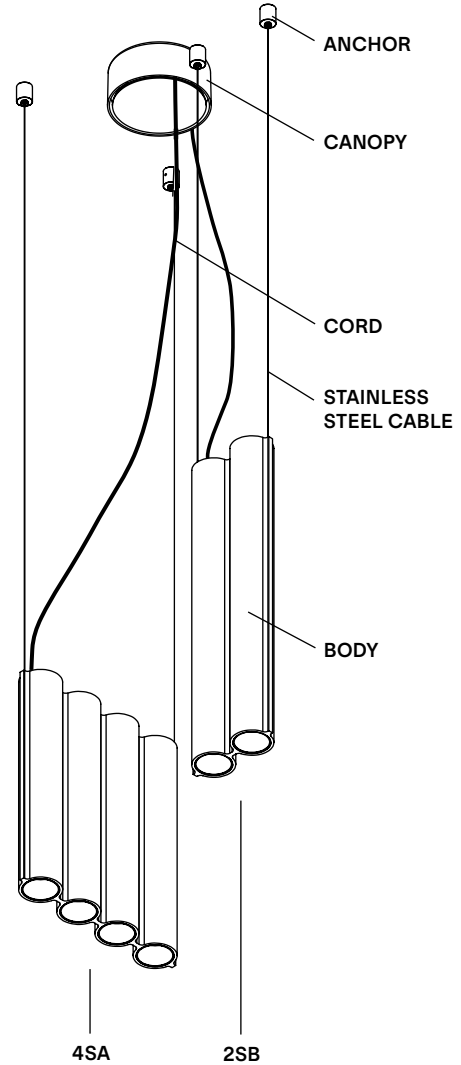

		Example	Fill with your selection
COLLECTION	SIL Silo	SIL	SIL
MODEL	10	10	10
BODIES (All choices other than Palette 1 are a monochrome cluster)	P1 Palette 1 (2SB in tumbled aluminum, 4SA in mirror polished aluminum) BK Textured black WH Textured white MR Mirror polished aluminum TA Tumbled aluminum BG Textured beige DP Wrinkled dusty pink TC Textured terracotta AU Textured aubergine OB Glossy oxblood MB Textured midnight blue CC Custom colour*	P1	
CORD	BK Black WH White CU Cumin	BK	
CANOPY AND ANCHORS	BK Textured black WH Textured white BG Textured beige DP Wrinkled dusty pink TC Textured terracotta AU Textured aubergine OB Glossy oxblood MB Textured midnight blue CC Custom colour*	BK	
MOUNTING	SM Surface mounted	SM	SM
COLOUR TEMPERATURE (CCT)	WL Warm light (2700K) NL Neutral light (3000K) D27 Dim to warm (2700K-2200K) D30 Dim to warm (3000K-2200K) CCT Other CCT available upon request**	WL	
DIMMING	ZT 0-10V (120VAC only) PH Phase dimming DA DALI (220-240VAC only)	ZT	
FULL SKU		SIL10P1BKBKSMWLZT	

NOTES

*Custom colour available upon request. Material library on website.

**Specific CCT selection only available in 100k increments, from 2200K to 4000K inclusively and not available with Dim-to-Warm feature.