

TRIBÙ

# ELIO

YABU PUSHELBERG



Elio, designed by Canadian design firm Yabu Pushelberg, is characterised by a softly rounded silhouette that draws inwards to create a cocoon effect. The armchair, lounge chair, high-back lounge chair and two-seater are framed by natural teak, which supports the seating shell. The seats are handwoven in Tricord rope.



**ARMCHAIR**  
02518



**LOUNGE CHAIR**  
02512



**LOUNGE CHAIR HIGH BACK**  
02520



**FOOTREST**  
02590



**POUFS**  
03502-03508-03509-03549



**1-SEATER MODULE**  
0350200



**2-SEATER MODULES**  
0350800



**3-SEATER MODULES**  
0350900



**DAYBED MODULES**  
0354900

## FABRICS & MATERIALS

### MATERIALS

#### Frame:

**Teak** is a beautiful and long-lasting wood, which is stable and resistant to weather and water. The wood is high in natural oils, which leads to low moisture absorption and high stability. Additionally, the wood is resistant to fungi, parasites, and insects.

After 75 to 80 years, a tree has reached maturity. The trees have been ringed, eventually losing the majority of their sap and are felled and sawed up about two years later. Drying the wood is a critical step that determines how it will react later. Drying time and speed are determined by the thickness of the material to achieve the ideal moisture level between 8 and 12 percent.

When it comes to quality, Tribù makes no concessions, using only carefully selected mature teak from three of the highest quality Indonesian plantations in Eastern Java, all of which meet the strictest environmental standards. Tribù Asia, a European-led organization, inspects local productions all year round.

#### Weave:

**Plaited Tricord®** is a brand new composite material for which Tribù has exclusivity. It is a unique combination of nautical and synthetic fibres. The inside consists of unbreakable polyester that gives it strength and stability. The outside is a combination of nautical fibres that create a surprisingly soft touch and natural appearance. The composition of these nautical fibres (polyofin) makes Tricord® completely resistant to outside influences: frost, water, fungi and UV-rays. The furniture is hand woven - no two pieces are ever alike. The unique craft appearance is part and parcel of the charm of the product and cannot be regarded as a fault. The backs of the Mood and CTR collection can be purchased individually and easily replaced if necessary.

#### FRAME

T-Teak

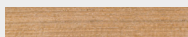

#### WEAVE

10-Linen

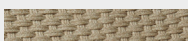

89-Wengé



### CUSHIONS

The filling has a cover in a laminated, water-repellent polypropylene material which prevents water from penetrating. The thread used to stitch the seams swells when getting wet, preventing water from penetrating through the seams. Moreover, the seams are protected on the inside with an extra covering. If nevertheless water should penetrate, the material is breathable, letting moisture out to prevent moulding. Fabrics available in category D, E & F.

Explore our materials and fabrics using our product configurator available on each product page of our website

## HOW TO MAINTAIN YOUR FURNITURE

**Teak** left in its natural state, is virtually maintenance-free. It can be left outside all year round, surviving even the most extreme weather conditions. New teak will experience natural oil surfacing that appears like a “watermark” or irregular pattern of discoloration. These areas are part of the natural maturing process and can be removed with gentle washing with Teak Super Cleaner.

Over time, untreated teak furniture which is exposed to sun and rain will turn silver grey. This process is cosmetic and does not harm the strength or quality of the wood.

To avoid the annual cleaning of the wood, you can apply Teak Sealer. Teak Sealer contains UV protection to slow down the graying from the sun as well as a fungicide to prevent the growth of mold and mildew. Teak Sealer can be applied to new teak or old teak furniture after it has been cleaned. We recommend using Teak Super Cleaner to clean soiled furniture. If Teak Sealer is applied every season, a simple cleaning with water and a pH neutral soap will do for years. Teak Sealer is a sealer and is not the same as varnish. It is breathable, letting the natural oils escape without bubbling or peeling like varnish.

Teak Protector protects the wood against stains and green deposit, without colouring the wood. We recommend to apply it after each cleaning.



TEAK SUPER CLEANER  
D9914



TEAK PROTECTOR  
D9912



TEAK SEALER  
D9959

Before use, we recommend to treat **the Tricord® weave** with Textile Protector which applies an invisible, dirt and water repellent film. The straps can be cleaned with clear water and a ph-neutral detergent or Synthetics Super Cleaner. Allow the detergent to act for a while, then rinse abundantly with clean water. Drying may take a while on cloudy days.

After cleaning, treat with Textile Protector. The cleaning will become easier and will require mainly rinsing with clean water.



TEXTILE PROTECTOR  
D9924



SYNTHETICS SUPER CLEANER  
D9922

## TECHNICAL DRAWINGS

**ARMCHAIR**  
02518-XX

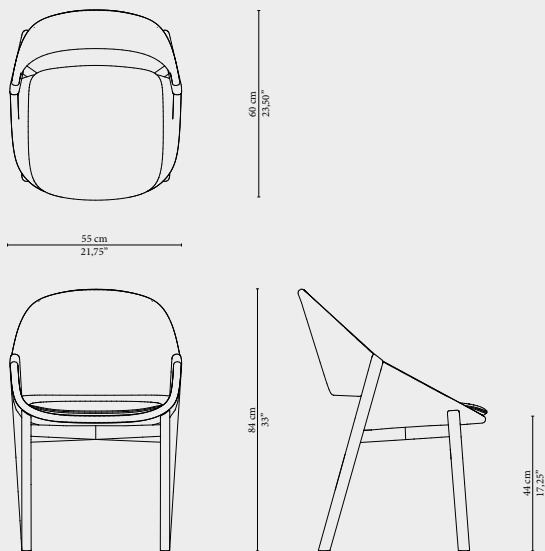

Seat cushion **C02518SW** is recommended for optimal seating

**LOUNGE CHAIR**  
02512-XX

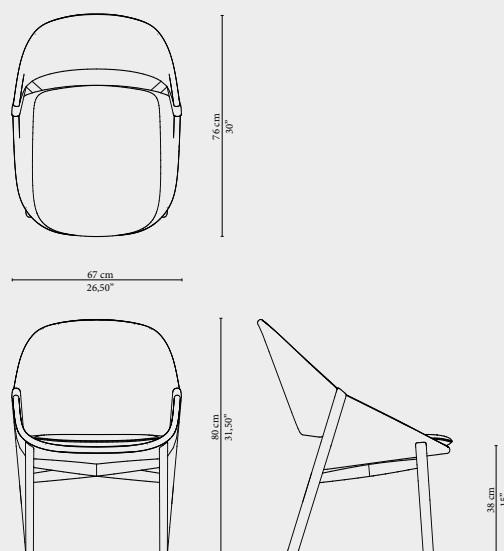

Seat cushion **C02512SW** is recommended for optimal seating

**LOUNGE CHAIR HIGH BACK**  
02520-XX

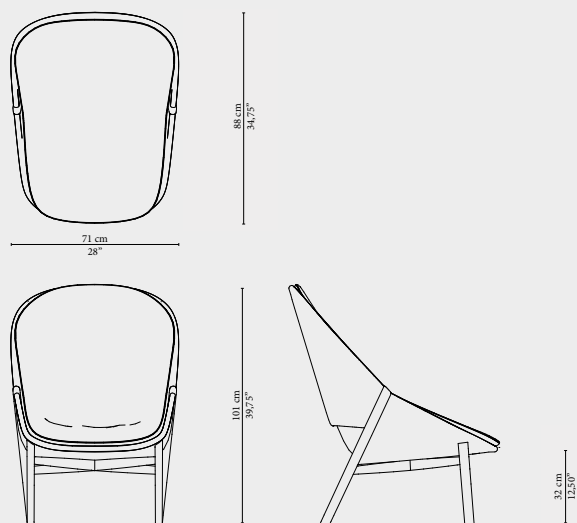

Cushion **C02520W** or back cushion **C02521BW** and seat cushion **C02521SW** are recommended for optimal seating

**FOOTREST**  
02590-XX

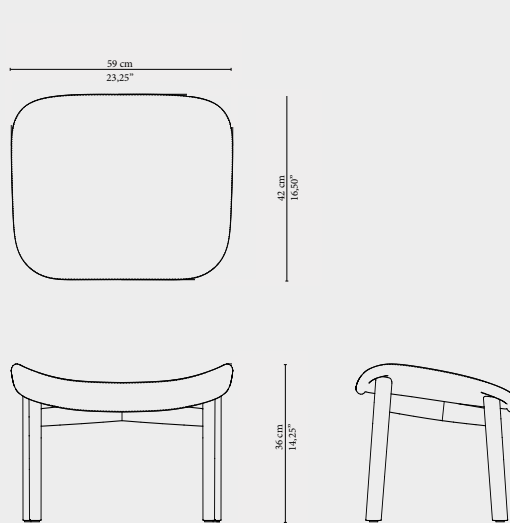

Cushion **C02590W** is recommended for optimal seating

## TECHNICAL DRAWINGS

### 1-SEATER MODULE 0350200-XX

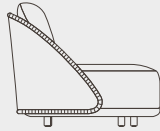
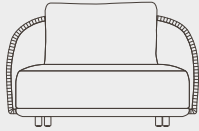

38 cm  
14.96"  
69.5 cm  
27.36"

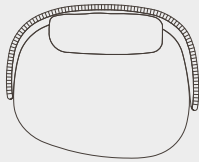

83.7 cm  
32.95"  
93.5 cm  
36.81"

106.5 cm  
41.93"

118 cm  
46.46"

0350200-10 ELIO SOFA 1-seater sofa  
C03502S-xxW ELIO SOFA 1-seater sofa  
C03500B-xxW ELIO SOFA 1-seater sofa

Back cushion **C03500BW** and seat cushion **C03502SW** are recommended for optimal seating



### 2-SEATER MODULES 0350800-XX

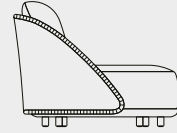
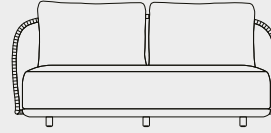

38 cm  
14.96"  
69.5 cm  
27.36"

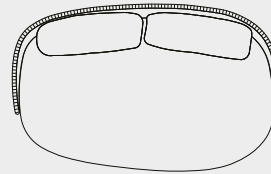

91.5 cm  
36.02"  
101.5 cm  
39.96"

153.5 cm  
60.43"

165.5 cm  
65.16"

0350800-10 ELIO SOFA 2-seater sofa backrest full  
C03508S-xxW ELIO SOFA 2-seater sofa backrest full seat cushion  
C03500B-xxW x2 ELIO SOFA 2-seater sofa backrest full back cushion

Back cushion **C03500BW** and seat cushion **C03508SW** are recommended for optimal seating



### 3-SEATER MODULES 0350900-XX

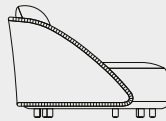
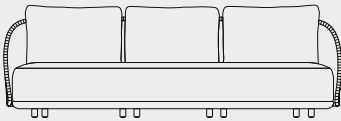

38 cm  
14.96"  
69.5 cm  
27.36"

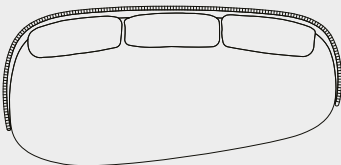

100.5 cm  
39.57"  
110.5 cm  
43.50"

222.5 cm  
87.60"

234.5 cm  
92.32"

0350900-10 ELIO SOFA 3-seater sofa full backrest  
C03509S-xxW ELIO SOFA 3-seater sofa full backrest seat cushion  
C03500B-xxW x3 ELIO SOFA 3-seater sofa full backrest back cushion

Back cushion **C03500BW** and seat cushion **C03509SW** are recommended for optimal seating



### 1-SEATER POUF 03502

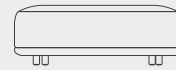

38 cm  
14.96"

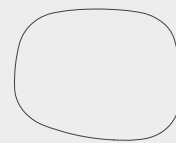

83.7 cm  
32.95"

106.5 cm  
41.93"

03502 ELIO SOFA 1-seater pouf  
C03502S-xxW ELIO SOFA 1-seater pouf se

Seat cushion **C03502SW** is recommended for optimal seating



## TECHNICAL DRAWINGS

### 2-SEATER POUF 03508

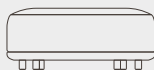
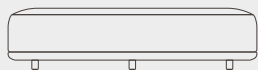

38 cm  
14.96"

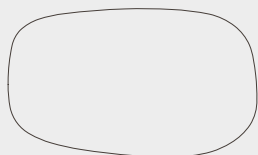

153.5 cm  
60.43"

91.5 cm  
36.02"

03508 ELIO SOFA 2-seater pouf  
C03508S-xxW ELIO SOFA 2-seater pouf seat cushion

Back cushion **C03500BW** and seat cushion **C03502SW** are recommended for optimal seating



### 3-SEATER POUF 03509

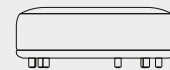
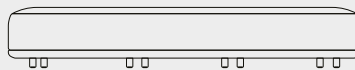

38 cm  
14.96"



222.5 cm  
87.60"

100.5 cm  
39.57"

03509 ELIO SOFA 3-seater pouf  
C03509S-xxW ELIO SOFA 3-seater pouf seat cushion

Back cushion **C03500BW** and seat cushion **C03508SW** are recommended for optimal seating



### DAYBED POUF 03549

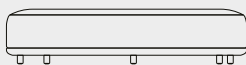
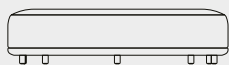

38 cm  
14.96"

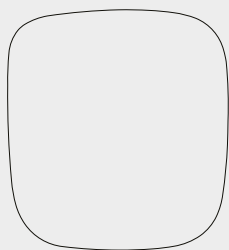

153 cm  
60.24"

167 cm  
65.75"

03549 ELIO SOFA daybed pouf  
C03549S-xxW ELIO SOFA daybed pouf seat cushion

Back cushion **C03500BW** and seat cushion **C03509SW** are recommended for optimal seating



### DAYBED MODULES 0354900-XX

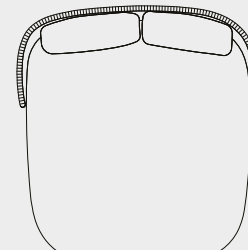
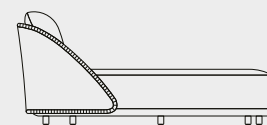
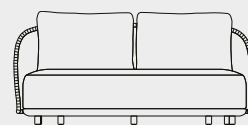

153 cm  
60.24"

165 cm  
64.96"

167 cm  
65.75"

177 cm  
69.69"

0354900-10 ELIO SOFA daybed backrest full  
C03549S-xxW ELIO SOFA daybed backrest full s  
C03500B-xxW x2 ELIO SOFA daybed backrest fu

Seat cushion **C03502SW** is recommended for optimal seating



TRIBÙ

## BE INSPIRED

Explore our collection of featured content, including images, videos, and social media assets, all available on our website. To access a wider variety of content, you'll encounter an extensive range of 2D and 3D files to enhance your creative projects.



# TRIBÙ

## PACKING LIST

ARTICLE NR.	ARTICLE NAME	BOX CONTENT	NR. OF BOXES	BOX DIMENSIONS (LXDXH)	VOLUME (M3 FT3)	GROSS WEIGHT BOX (KG LB)
02518-XX	ARMCHAIR	1	1	62x58x87cm 24.5x22.75x34.25"	0.3 10.6	13 28.7
02512-XX	LOUNGE CHAIR	1	1	79x69x85cm 31x27.25x33.5"	0.5 17.7	18 39.7
02520-XX	LOUNGE CHAIR HIGH BACK	1	1	91x75x104cm 35.75x29.5x41"	0.7 24.7	23 50.7
02508-XX	SOFA 2-SEATER	1	1	158x90x85cm 62.25x35.5x33.5"	1.2 42.4	43.6 96.1
02590-XX	FOOTSTOOL	1	1	67x49x44cm 26.5x19.25x17.25"	0.1 3.5	7.4 16.3
0350200-XX	1-SEATER MODULES					
0350800-XX	2-SEATER MODULES					
0350900-XX	3-SEATER MODULES					
03502	1-SEATER POUF					
03508	2-SEATER POUF					
03509	3-SEATER POUF					
03549	DAYBED POUF					
0354900-XX	DAYBED MODULES					