

Base Kitchen,
by Kettal Studio

kettal

Base Kitchen
Sink top,
by Kettal Studio

kettal

Sink top

Designer
Kettal Studio

Collection
Kitchen

Reference
A6800AGUOI
A6800AGUOD

1/2

This modular kitchen structure offers infinite solutions. An aluminium supporting frame can be teamed with a number of stoneware modules in various combinations whilst maintaining its authentic linear design.

This design features clean, smooth surfaces, with no corners, for easy cleaning and maintenance.

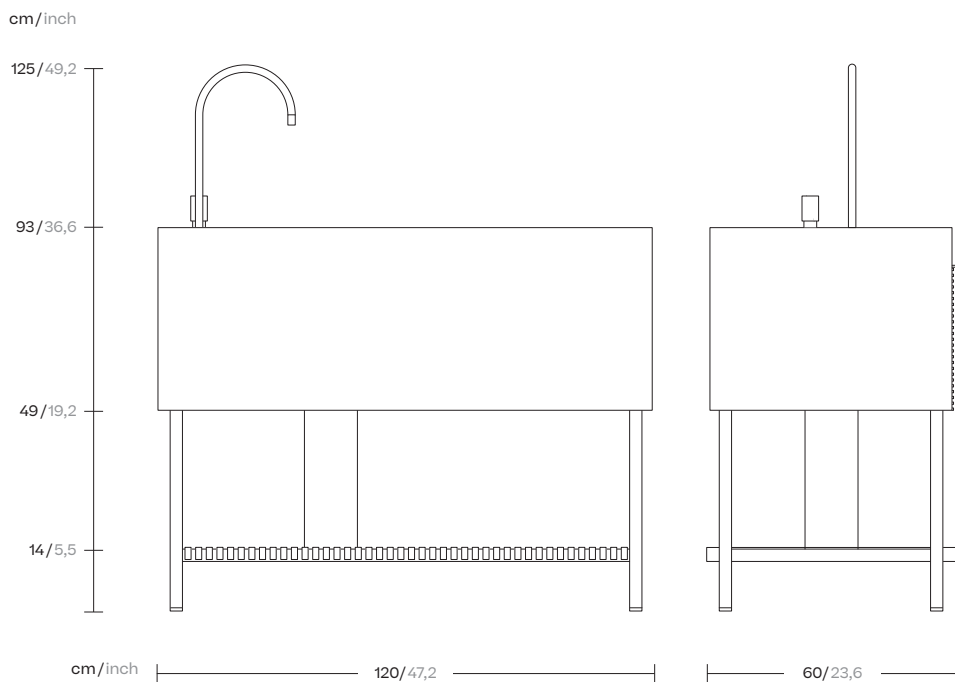

kettal

Sink top

Designer
Kettal Studio

Collection
Kitchen

Reference
A6800AGU01
A6800AGU0D

2/2

Materials

Aluminium. Antioxy, Heavy Load, Resistant En-1421, Kettalize-It, Anti-Scratch, Easy Clean Flame Retardant M1, Eco Friendly Ecoembes Recycling Process

Teak. Eco-friendly, A-grade

Ceramic

Other characteristics

 Adjustable Legs

 Underporch

Maintenance

Protect surfaces with barrier elements like film, paper, and peelable lacquers before placement and handling. If accidental contamination or splashing of strong alkalis or acids occurs, wash the affected area with a large amount of clean water, especially cut-outs or holes and cavities.

We recommend treating the wood with sealer every three months, or more frequently in the case of hotel and catering establishments. To restore the teak to its original appearance, sand the entire surface and apply the sealer.

Faucet, Drainpipe and water inlet

Iconic black matt finish. Faucet model K-CE23U, Water mixer model M2L/ME. Water inlet installation 3/8. Water drain pipe diameter 40mm.

General Warnings

It must be sheltered from direct rain. The kitchen's location should be roofed. The kitchen can be in a place without a roof as long as it is covered when it rains.

Colors

Structure



Carbon
737

Lower trays



Teak
904

Countertop

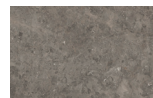

Du Gent Grey
CM2

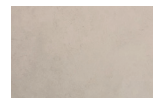

Neutral Caliza
CM3

Detail



Base Kitchen
Work top,
by Kettal Studio

kettal

Work top

Designer
Kettal Studio

Collection
Kitchen

Reference
A6800ENC00

1/2

cm/inch

This modular kitchen structure offers infinite solutions. An aluminium supporting frame can be teamed with a number of stoneware modules in various combinations whilst maintaining its authentic linear design.

This design features clean, smooth surfaces, with no corners, for easy cleaning and maintenance.

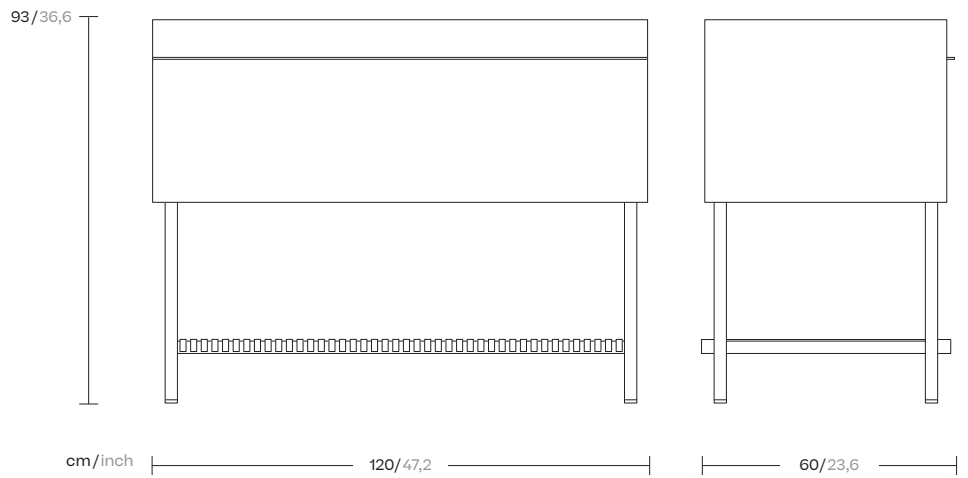

kettal

Work top

Designer
Kettal Studio

Collection
Kitchen

Reference
A6800ENC00

2/2

Materials

Aluminium. Antioxy, Heavy Load, Resistant En-1421, Kettalize-It, Anti-Scratch, Easy Clean Flame Retardant M1, Eco Friendly Ecoembes Recycling Process

Teak. Eco-friendly, A-grade

Ceramic

Other characteristics

 Adjustable Legs

 Underporch

General Warnings

It must be sheltered from direct rain. The kitchen's location should be roofed. The kitchen can be in a place without a roof as long as it is covered when it rains.

Colors

Structure



Carbon
737

Lower trays



Teak
904

Countertop

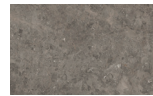

Du Gent Grey
CM2



Neutral Caliza
CM3

Maintenance

Protect surfaces with barrier elements like film, paper, and peelable lacquers before placement and handling. If accidental contamination or splashing of strong alkalis or acids occurs, wash the affected area with a large amount of clean water, especially cut-outs or holes and cavities.

We recommend treating the wood with sealer every three months, or more frequently in the case of hotel and catering establishments. To restore the teak to its original appearance, sand the entire surface and apply the sealer.

Detail



Base Kitchen
Work top + Kitchen bar,
by Kettal Studio

kettal

Work top + Kitchen bar

Designer
Kettal Studio

Collection
Kitchen

Reference
A6800ENCKB

1/2

This modular kitchen structure offers infinite solutions. An aluminium supporting frame can be teamed with a number of stoneware modules in various combinations whilst maintaining its authentic linear design.

This design features clean, smooth surfaces, with no corners, for easy cleaning and maintenance.

cm/inch

97/38,1

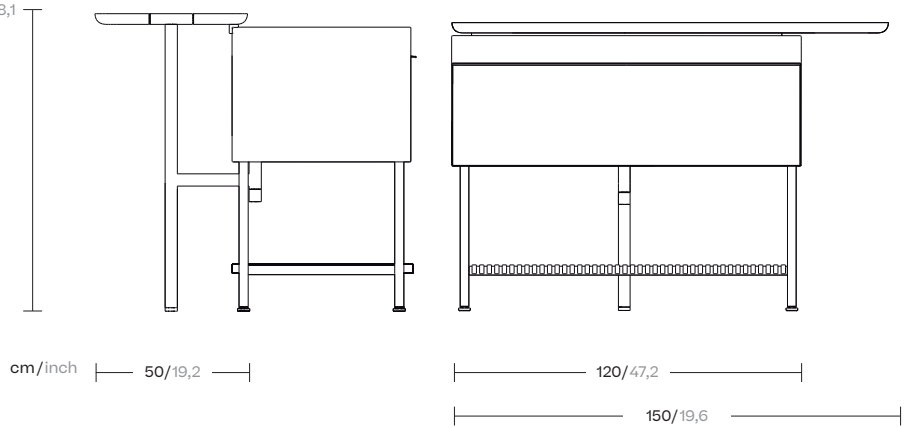

kettal

Work top + Kitchen bar

Designer
Kettal Studio

Collection
Kitchen

Reference
A6800ENCKB

2/2

Materials

Aluminium. Antioxy, Heavy Load, Resistant En-1421, Kettalize-It, Anti-Scratch, Easy Clean Flame Retardant M1, Eco Friendly Ecoembes Recycling Process

Teak. Eco-friendly, A-grade

Ceramic

Other characteristics

 Adjustable Legs

 Underporch

Maintenance

Protect surfaces with barrier elements like film, paper, and peelable lacquers before placement and handling. If accidental contamination or splashing of strong alkalis or acids occurs, wash the affected area with a large amount of clean water, especially cut-outs or holes and cavities.

We recommend treating the wood with sealer every three months, or more frequently in the case of hotel and catering establishments. To restore the teak to its original appearance, sand the entire surface and apply the sealer.

General Warnings

It must be sheltered from direct rain. The kitchen's location should be roofed. The kitchen can be in a place without a roof as long as it is covered when it rains.

Colors

Structure



Carbon
737

Lower trays



Teak
904

Countertop

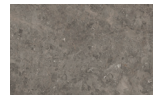

Du Gent Grey
CM2



Neutral Caliza
CM3

The kitchen bar can be mounted in two position

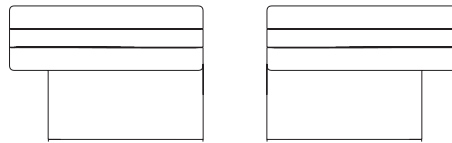

Base Kitchen
Cook top,
by Kettal Studio

kettal

Cook top

Designer
Kettal Studio

Collection
Kitchen

Reference
A6800GAS2Q

1/3

This modular kitchen structure offers infinite solutions. An aluminium supporting frame can be teamed with a number of stoneware modules in various combinations whilst maintaining its authentic linear design.

This design features clean, smooth surfaces, with no corners, for easy cleaning and maintenance.

cm/inch

93/36,6

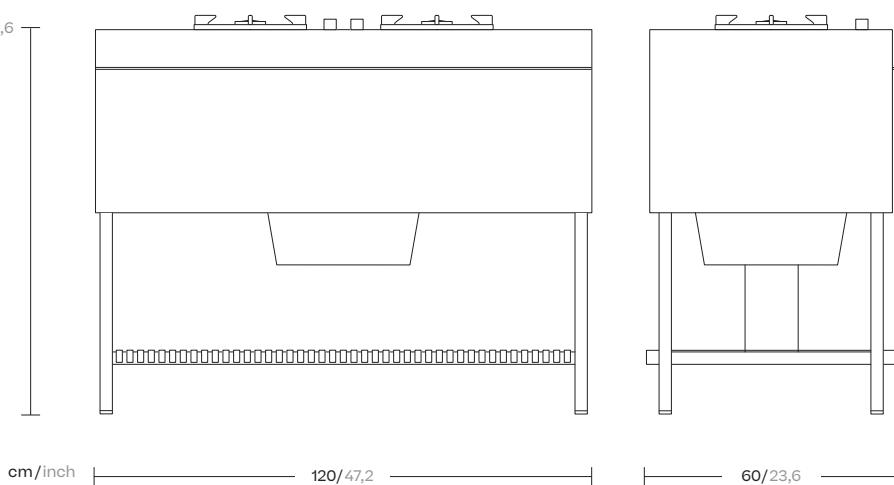

cm/inch

120/47,2

60/23,6



kettal

Cook top

Designer
Kettal Studio

Collection
Kitchen

Reference
A6800GAS2Q

2/3

Technical specifications

230V 50 - 0.6VA Electrical connection

1,5VDC Battery spark ignition

10kW - 720Bel. Gr/h

Materials

Aluminium. Antioxy, Heavy Load, Resistant En-1421, Kettalize-It, Anti-Scratch, Easy Clean Flame Retardant M1, Eco Friendly Ecoembes Recycling Process

Brass and cast iron black coated burners

Teak. Eco-friendly, A-grade

Ceramic

Other characteristics

 Adjustable Legs

 Underporch

Colors

Structure



Carbon
737

Lower trays



Teak
904

Countertop

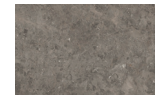

Du Gent Grey
CM2

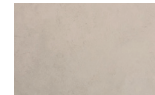

Neutral Caliza
CM3

Maintenance

Pan support: We recommend that dirty pan supports be soaked for about an hour in a liquid soap and soda mixture before being rubbed with a cloth or soft sponge. The silver-colored scratches that sometimes appear on the pan supports are caused by the base of your pan(s). Higher-grade pans definitely have a softer base and the material can sometimes rub off. With the rough side of a (scouring) sponge you can remove this.

Burner caps: We recommend that dirty burner caps be soaked for about an hour in a liquid soap and soda mixture before being rubbed with a cloth or a (scouring) sponge.

Black coated burners: Black coated burners can be left to soak in cleaning vinegar overnight and then cleaned with a soft sponge and a little soap. Note: The parts must not be cleaned with soda as this can damage the product. Note: The burner is not suitable for the dishwasher as this can damage the product.

Please note: The various components of the burners are not suitable for cleaning in a dishwasher. The dishwasher salt can cause a dull appearance.

Detail



Gas connection

- Check that installation or local distribution regulations (type of gas and gas pressure) match the setting value of this device.
- This device is not equipped with a combustion gas drain installation. Installation and connection must comply with the regulations in force locally and nationwide. You must check the regulations in regards to ventilation requirements
- The gas connection must comply with the general regulations. We recommend to connect the hob with a fixed gas pipeline or to use an approved gas hose.
- Before using the cooking unit check all the connections for leaks with soapy water.
- The electrical installation must conform to the national and local regulations.
- Power socket and plug must always be reachable.
- Connect the unit with the supplied plug to an earthed socket.
- Damage to the connection cable may only be replaced by the manufacturer, or an approved Installer. This to prevent dangerous situations.
- The spark ignition operates through a battery AA.
- The battery is positioned in the casing at the underside
- Replace the battery if the spark ignition does not operate

General Warnings

- Only use the gas hob for the preparation of dishes. This appliance is not suitable for heating your home
- Always place pans on the pan support, never directly on the burner top
- Check the product regularly for damage. Do not use the product when damaged, repair it immediately
- The user is responsible for the proper use and good state of the system
- When used incorrectly, the manufacturer is not liable for any damages.
- It must be sheltered from direct rain. The kitchen's location should be roofed. The kitchen can be in a place without a roof as long as it is covered when it rains

Overheating and fire hazards

- Use the burner only with a pan or a wok on the pan support. Warning: an empty pan may overheat
- Overheated oil or butter can easily ignite. Never put out with water. You can smother the flames by closing the pan with a lid.
- Do not flambé under a cooker hood, this can cause a fire.
- Never put flammable objects on the hob.
- Never place a grill or griddle over two burners.
- Do not use pans with a larger base diameter than the pan support. We recommend for the 2 and 3KW burners a pan with a maximum base diameter of 230 mm and for the 5KW burner a maximum base of 270 mm.

Hot parts

- Parts of the burner and the worktop surrounding the burner may become hot during use and will remain hot for a long period after use. Please take care not to touch these parts until they have fully cooled.
- Please be aware that if you use a pan with a larger base diameter than the pan support (see point 14) there is a possibility that the control knobs may become hot.
- Please be aware that the flame should always remain beneath the base of the pan (unless you are stir frying with a wok). Flames rising against the side of the pan will not be effective and will produce unwanted overheating.
- It is very important that children remain at a distance

Base Kitchen
Flat lid Barbaque module,
by Kettal Studio

kettal

Flat lid Barbaque module

Designer
Kettal Studio

Collection
Kitchen

Reference
A6800BBQFL

1/3

This modular kitchen structure offers infinite solutions. An aluminium supporting frame can be teamed with a number of stoneware modules in various combinations whilst maintaining its authentic linear design.

This design features clean, smooth surfaces, with no corners, for easy cleaning and maintenance.

cm/inch

98/38,5
93/36,6

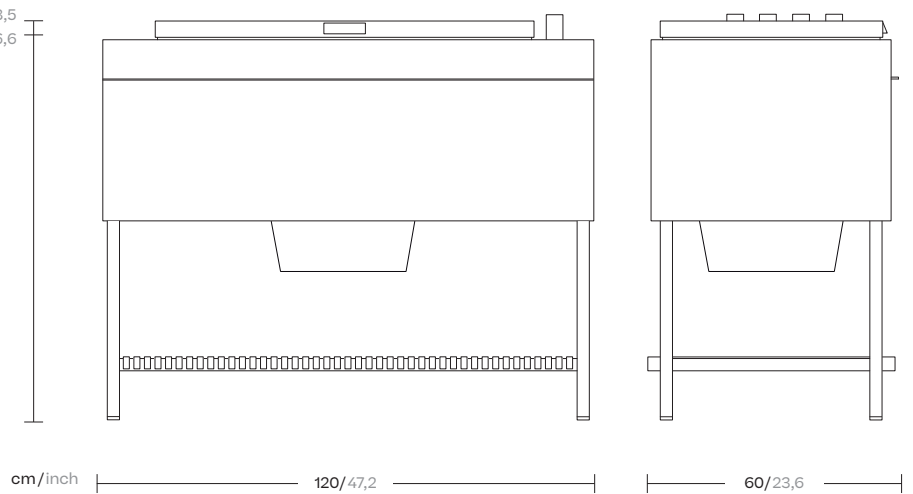

kettal

Flat lid Barbaque module

Designer
Kettal Studio

Collection
Kitchen

Reference
A6800BBQFL

2/3

Technical specifications

48,000 BTU (British Thermal Unit)

697 Grill heat flux

Materials

Aluminium. Antioxy, Heavy Load, Resistant En-1421, Kettalize-It, Anti-Scratch, Easy Clean Flame Retardant M1, Eco Friendly Ecoembes Recycling Process

Stainless steel

Teak. Eco-friendly, A-grade

Ceramic

Other characteristics

 Adjustable Legs

 Underporch

Colors

Structure



Carbon
737

Lower trays



Teak
904

Countertop

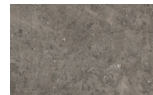

Du Gent Grey
CM2

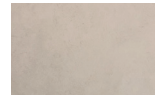

Neutral Caliza
CM3

Maintenance

Protect surfaces with barrier elements like film, paper, and peelable lacquers before placement and handling.

If accidental contamination or splashing of strong alkalis or acids occurs, wash the affected area with a large amount of clean water, especially cut-outs or holes and cavities.

We recommend treating the wood with sealer every three months, or more frequently in the case of hotel and catering establishments. To restore the teak to its original appearance, sand the entire surface and apply the sealer.

Detail

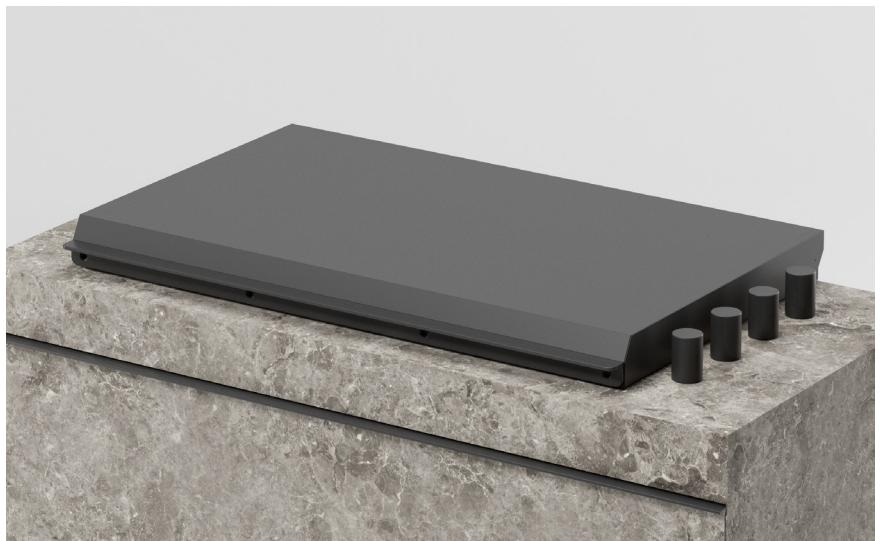

Flat lid Barbaque module

Designer
Kettal Studio

Collection
Kitchen

Reference
A6800BBQFL

3/3

Gas connection

- Barbecue universal gas inlet ready to install with LPG hose and regulator, brass adaptor (according to local specifications) and sealing washer.
- Small portable cylinders max 6Kg. Check with manufacturer for maximum dimensions in each country.
- Do not cover the countertop lid or bottom air ventilation area. This vent area is to allow air into the enclosure for the correct combustion of gases and for the correct exhausting of the products of combustion.
- Slim flat cover must not be closed when the burners are operating.
- Universal LPG or propane must be carried out by a qualified licensed person.

General Warnings

It must be sheltered from direct rain. The kitchen's location should be roofed. The kitchen can be in a place without a roof as long as it is covered when it rains

Base Kitchen
Cooking high lid
Barbaque module,
by Kettal Studio

kettal

Cooking high lid Barbaque module

Designer
Kettal Studio

Collection
Kitchen

Reference
A6800BBQHL

1/3

This modular kitchen structure offers infinite solutions. An aluminium supporting frame can be teamed with a number of stoneware modules in various combinations whilst maintaining its authentic linear design.

This design features clean, smooth surfaces, with no corners, for easy cleaning and maintenance.

cm/inch

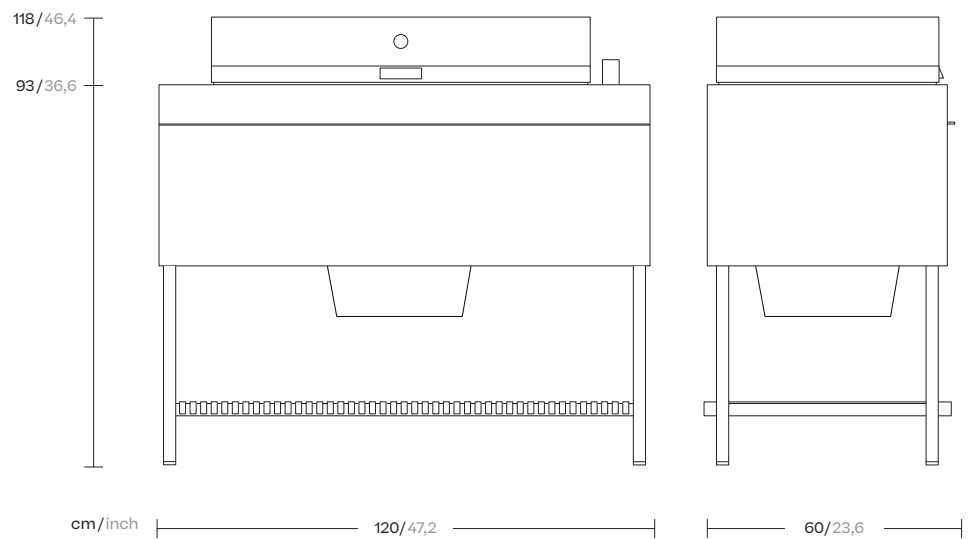

kettal

Cooking high lid Barbaque module

Designer
Kettal Studio

Collection
Kitchen

Reference
A6800BBQHL

2/3

Technical specifications

48,000 BTU (British Thermal Unit)

697 Grill heat flux

Materials

Aluminium. Antioxy, Heavy Load, Resistant En-1421, Kettalize-It, Anti-Scratch, Easy Clean Flame Retardant M1, Eco Friendly Ecoembes Recycling Process

Stainless steel

Teak. Eco-friendly, A-grade

Ceramic

Other characteristics

 Adjustable Legs

 Underporch

Colors

Structure



Carbon
737

Lower trays



Teak
904

Countertop

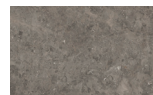

Du Gent Grey
CM2

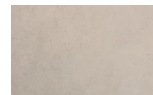

Neutral Caliza
CM3

Maintenance

Protect surfaces with barrier elements like film, paper, and peelable lacquers before placement and handling.

If accidental contamination or splashing of strong alkalis or acids occurs, wash the affected area with a large amount of clean water, especially cut-outs or holes and cavities.

We recommend treating the wood with sealer every three months, or more frequently in the case of hotel and catering establishments. To restore the teak to its original appearance, sand the entire surface and apply the sealer.

Detail



Cooking high lid Barbaque module

Designer
Kettal Studio

Collection
Kitchen

Reference
A6800BBQHL

3/3

Gas connection

- Barbecue universal gas inlet ready to install with LPG hose and regulator, brass adaptor (according to local specifications) and sealing washer.
- Small portable cylinders max 6Kg. Check with manufacturer for maximum dimensions in each country.
- Do not cover the countertop lid or bottom air ventilation area. This vent area is to allow air into the enclosure for the correct combustion of gases and for the correct exhausting of the products of combustion.
- Slim flat cover must not be closed when the burners are operating.
- Universal LPG or propane must be carried out by a qualified licensed person.

General Warnings

It must be sheltered from direct rain. The kitchen's location should be roofed. The kitchen can be in a place without a roof as long as it is covered when it rains

Base Kitchen
Cupboard module,
by Kettal Studio

kettal

Cupboard module

Designer
Kettal Studio

Collection
Kitchen

Reference
KSA602230

1/2

cm/inch

This modular kitchen structure offers infinite solutions. An aluminium supporting frame can be teamed with a number Materials of stoneware modules in various combinations whilst maintaining its authentic linear design.

This design features clean, smooth surfaces, with no corners, for easy cleaning and maintenance.

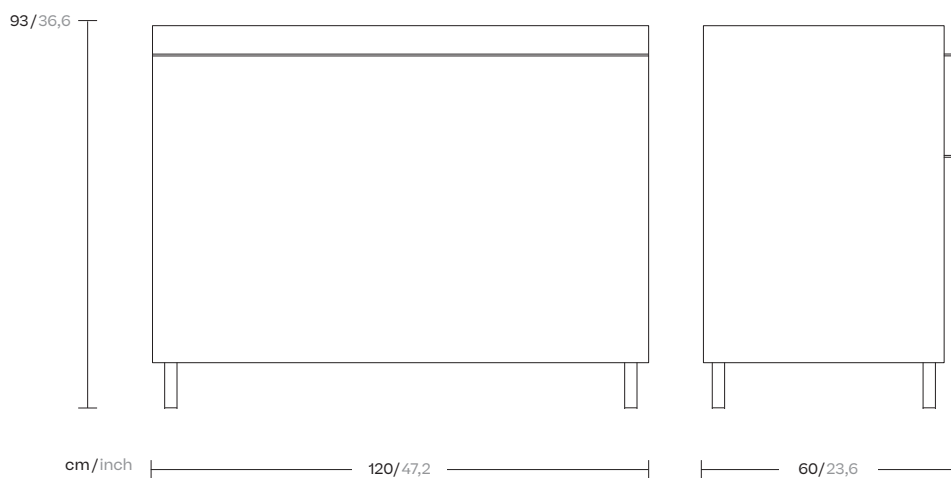

kettal

Cupboard module

Designer
Kettal Studio

Collection
Kitchen

Reference
KSA602230

2/2

Materials

Aluminium. Antioxy, Heavy Load, Resistant En-1421, Kettalize-It, Anti-Scratch, Easy Clean Flame Retardant M1, Eco Friendly Ecoembes Recycling Process

Ceramic

Colors

Structure



Carbon
737

Countertop

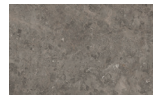

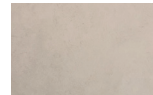

Du Gent Grey
CM2



Neutral Caliza
CM3

Other characteristics

 Adjustable Legs

 Underporch

Maintenance

Protect surfaces with barrier elements like film, paper, and peelable lacquers before placement and handling. If accidental contamination or splashing of strong alkalis or acids occurs, wash the affected area with a large amount of clean water, especially cut-outs or holes and cavities.